

This system allows the installation of a series of 1/8 solenoid valves with different functions: 5 / 2 mono-stable 5 / 2 bistable and 5 / 3, through a printed circuit board inserted in an aluminum shell with a female connection SUB-D 25 pin; this avoids the wiring of each valve. Thanks to a simple and intuitive coding system, it is possible to order the island with mounted and tested solenoid, or also to just order the island and mount the solenoid valves at a later date.

Ce système permet le montage d'une série d'électrovalves de 1/8 de différentes fonctions: 5/2 monostable, 5/2 bistable et 5/3 grâce à un circuit centralisé en aluminium avec une connection femelle SUB-D qui évite de cabler chaque valve.

Grâce au système de codification simple vous pouvez commander un îlot avec des valves simples ou doubles bobines testées et montées et les ajouter au fur et à mesure.

Questo sistema permette il montaggio di una serie di elettrovalvole da 1/8 di diversa funzione: 5/2 monostabile 5/2 bistabile e 5/3, grazie ad un circuito stampato inserito in un guscio di alluminio con una connessione femmina SUB-D 25 pin, si eviterà così il cablaggio di ogni singola valvola. Grazie ad un sistema di codifica molto semplice ed intuitivo, è possibile ordinare l'isola con elettrovalvole montate e collaudate oppure è possibile ordinare la sola base montando le elettrovalvole in un secondo tempo.

ORDERING CODE / CODIFICATION / CHIAVE DI CODIFICA

S M 2 0 0 0 0 0 0 0 3

N° STATIONS / N° STATION / N° POSTI

02
04
06
08
10
12

2 = D-SUB connector with 3m cable included
Connecteur D-SUB avec câble de 3 m inclus
Connettore D-SUB con cavo da 3 mt incluso

SHORT CODE / CODE COURT / CODICE BREVE

S= VY85ELM00 (5/2 monostable / monostable / monostabile)
D= VY85ELB00 (5/2 bistable / bistable / bistabile)
C= VY86ELMCC (5/3 closed centers / centre ferme / centri chiusi)
O= VY86ELMCA (5/3 open centers / centre ouvert / centri aperti)
P= VY86ELMCP (5/3 pressurized centers / centre en pression / centri in pressione)
B= BLANKING PLATE / PLAQUE DE FERMETURE / PIASTRINA DI CHIUSURA

For every requested double solenoid valve, it is necessary to consider 2 stations (one is for the valve and the other is for the included adaptor).

Pour chaque valve à deux bobines, il est nécessaire d'avoir deux stations l'une pour la valve et l'autre pour l'adaptateur qui y est compris.

Per ogni valvola doppio solenoide, si deve considerare 2 postazioni (una per la valvola e l'altra per l'adattatore che è compreso).

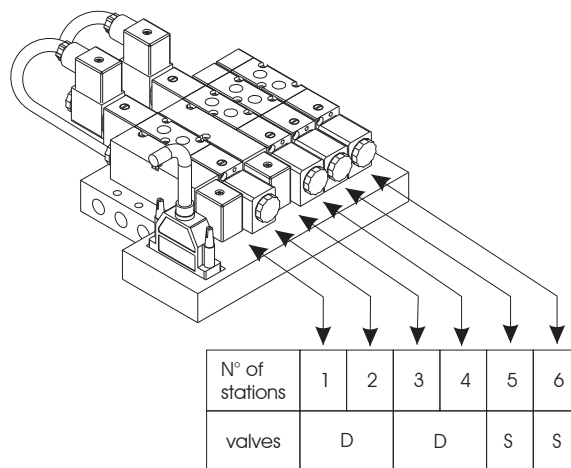

TECHNICAL DATA / DONNÉES TECHNIQUES / DATI TECNICI

Operating temperature range / Température d'utilisation / Temperatura di esercizio	-0°C / + 50°C
Max operating pressure / Pression max d'utilisation / Pressione massima di esercizio	10 bar
Flow rate / Débit / Portata	550 NI/min
Visualization / Visualization / Segnalazione di stato	Red Led / Led rouge / Led rosso
Voltage / Tension d'alimentation / Tensione di alimentazione	24 VDC - 24VAC
Connections / Connections / Connessioni	1/8 Out · 1/4 In
Electric connections / Connexions / Connessione ingresso	Sub-D 25 pin
Maximum frequency / Fréquence max. / Frequenza massima	5 cicli/sec.

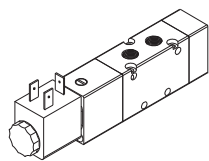

1/8 - 5/2 monostable
1/8 - 5/2 monostable
1/8 - 5/2 monostabile

CODE
VY85ELM00-T

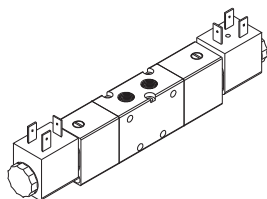
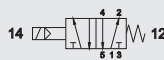

1/8 - 5/2 bistable
1/8 - 5/2 bistable
1/8 - 5/2 bistabile

CODE
VY85ELB00-T

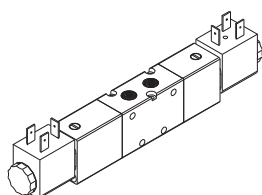

1/8 - 5/3 monostable
1/8 - 5/3 monostable
1/8 - 5/3 monostabile

CODE
VY86ELMCC-T
VY86ELMCA-T
VY86ELMCP-T

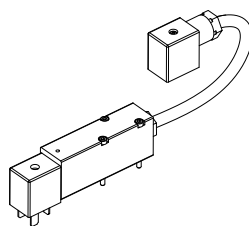
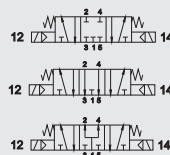

ADAPTOR FOR DOUBLE SOLENOID VALVE
ADAPTATEUR POUR VALVE DOUBLE BOBINE
ADATTATORE PER VALVOLA DOPPIO SOLENOIDE

CODE
VX0001

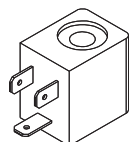

COIL 24 VDC
BOBINE 24 VDC
BOBINE 24 VDC

CODE
BO4001024

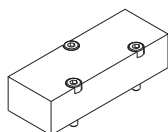

BLANKING PLATE
PLAQUE DE FERMETURE
PIASTRINA DI CHIUSURA

CODE
SB401212

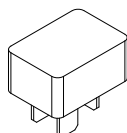

BLANKING PLATE FOR ELECTRIC CONNECTION
BOUCHON POUR CONNEXION ELECTRIQUE
TAPPO PER CONNESSIONE ELETTRICA

CODE
VX0005

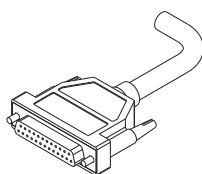

CONNECTOR D-SUB 25 PIN CABLE 1,5 MT
CONNECTEUR D-SUB 25 PIN CABLE 1,5 MT
CONNETTORE D-SUB 25 PIN CON CAVO 1,5 MT

CODE
VX0004

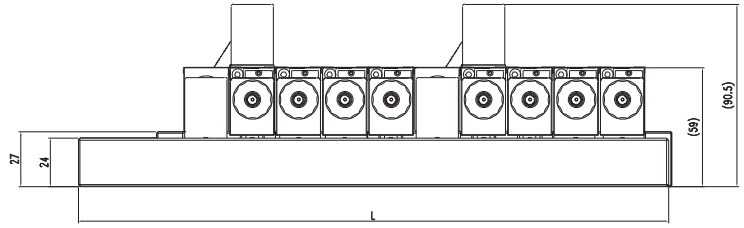
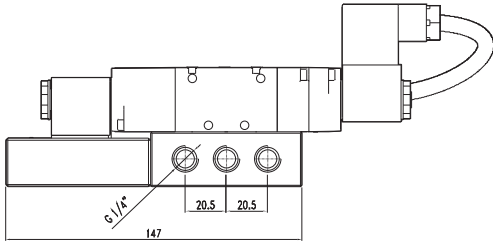

N° POS	L	L1	L2
2	109.5	72	59
4	155.5	118	105
6	201.5	164	151
8	247.5	210	197
10	293.5	256	243
12	339.5	302	289

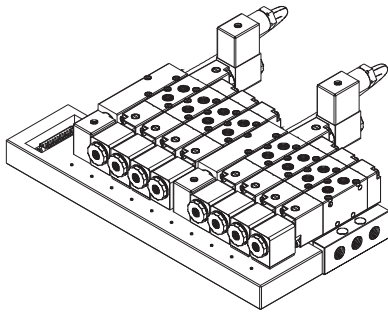
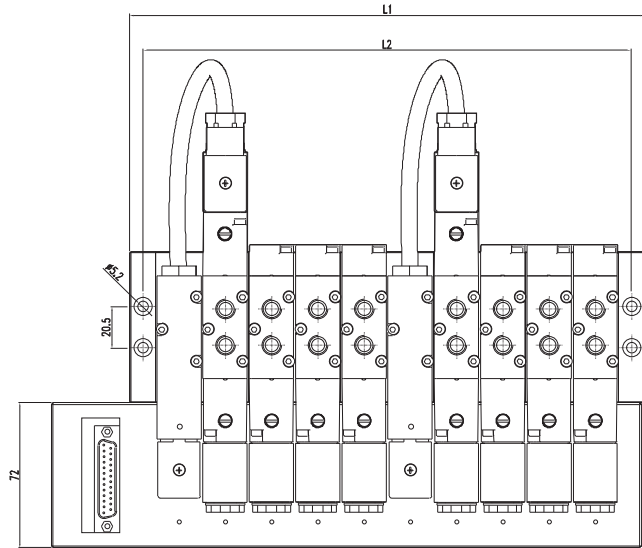

ELECTRICAL CONNECTOR / CONNEXION ELECTRIQUE / CONNESSIONE ELETTRICA

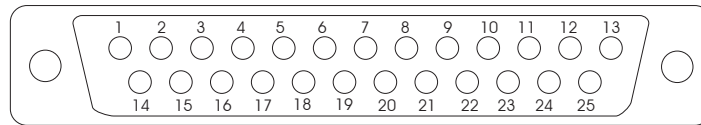

PIN	COLOR / COULEUR / COLORE	COIL / BOBINE / BOBINA
1	brown / marron / marrone	1
2	brown white / marron blanc / marrone bianco	2
3	red / rouge / rosso	3
4	red black / rouge noir / rosso nero	4
5	orange / orange / arancio	5
6	orange black / orange noir / arancio nero	6
7	yellow / jaune / giallo	7
8	yellow black / jaune noir / giallo nero	8
9	green / vert / verde	9
10	green black / vert noir / verde nero	10
11	blue / bleu / blu	11
12	blue white / bleu blanc / blu bianco	12
14	purple white / violet blanc / viola bianco	13

PIN	COLOR / COULEUR / COLORE	COIL / BOBINE / BOBINA
15	gray / gris / grigio	14
16	gray black / gris noir / grigio nero	15
17	white / bianc / bianco	16
18	white black / bianc noir / bianco nero	17
19	pink / rose / rosa	18
20	pink black / rose noir / rosa nero	19
21	white red / bianc rouge / bianco rosso	20
22	white blue / bianc bleu / bianco blu	21
23	light blue / azur / azzurro	22
24	light blue black / azur noir / azzurro nero	23
13	purple / violet / viola	COM
25	light green / vert clair / verdino	COM