

PRESSURE GAUGE BACK CONNECTION
MANOMÈTRE FIXATION DORSALE
 MANOMETRO ATTACCO POSTERIORE

CODE	SIZE	REG.
XB1712	D.40 1/8	0-4 bar
XB1716	D.40 1/8	0-6 bar
XB1715	D.40 1/8	0-10 bar
XB1714	D.40 1/8	0-12 bar
XB2116	D.50 1/8	0-6 bar
XB2114	D.50 1/8	0-12 bar

Ø	A	B	C	D	E	F	CH
40	40	25	3	41.5	10	G1/8	12
50	50	26	3.8	47	13	G1/8	14

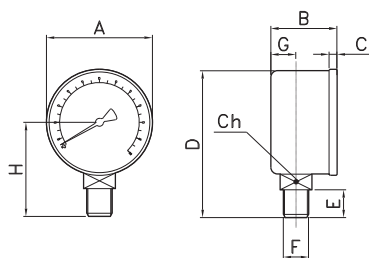
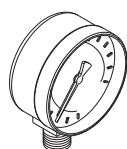

PRESSURE GAUGE BOTTOM CONNECTION
MANOMÈTRE FIXATION RADIALE
 MANOMETRO ATTACCO RADIALE

CODE	SIZE	REG.
XB2216	D.40 1/8	0-6 bar
XB2214	D.40 1/8	0-12 bar
XB2314	D.50 1/8	0-12 bar

Ø	A	B	C	D	E	F	G	H	CH
40	40	23.5	3	56	10	G1/8	9.5	36	12
50	50	26	3.8	70	13	G1/8	10.3	45	14

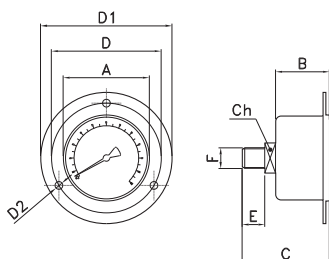

PRESSURE GAUGE 3 HOLE FLANGE
MANOMÈTRE A COLLERETTE 3 TROUS
 MANOMETRO FLANGIA A 3 FORI

CODE	SIZE	REG.
XB2412	D.40 1/8	0-4 bar
XB2416	D.40 1/8	0-6 bar
XB2415	D.40 1/8	0-10 bar
XB2414	D.40 1/8	0-12 bar

Ø	A	B	C	D	D1	D2	E	F	CH
40	40	26	42.5	51	61	3.6	10	G1/8	12

AIR-SUCTION LOCK ALLOW COLLECTION OF AIR FROM FRL UNIT.
LA PRISE D'AIR PERMET LE PRÉLÈVEMENT D'AIR DU GROUPE FRL.
 LA PRESA D'ARIA PERMETTE IL PRELIEVO D'ARIA DAL GRUPPO FRL.

CODE	SIZE
YB141	1/8 - 1/4
YB142	3/8 - 1/2
YB143	3/4 - 1"



BOWL WITH INLET FOR CONTINUOUS OIL FEED.
CUVE AVEC RACCORD POUR REMPLISSAGE HUILE.
 TAZZA CON ATTACCO PER CARICAMENTO OLIO CONTINUO.

CODE	SIZE
YB271	1/8 - 1/4
YB272	3/8 - 1/2
YB273	3/4 - 1"



OIL
HUILE
 OLIO

CODE	SIZE
YB32	1 Lt



AUTOMATIC RELIEF WITH INLET.
PURGE AUTOMATIQUE AVEC RACCORD POUR BAC.
 SCARICO AUTOMATICO COMPLETO DI ATTACCO PER TAZZA.

CODE	SIZE
YB291	1/8 - 1/4
YB292	3/8 - 1/2
YB293	3/4 - 1"



FASTENING BRACKET FOR REGULATORS.
ÉTRIER DE FIXATION POUR RÉGULATEURS.
 STAFFA DI FISSAGGIO PER REGOLATORI.

CODE	SIZE
YB301	1/8 - 1/4
YB302	3/8 - 1/2



FASTENING BRACKET FOR REG. DISTANCE FROM THE WALL 2,5 CM.
ÉTRIER DE FIXATION POUR RÉGULATEURS. DISTANCE DU MUR 2,5 CM.
 STAFFA DI FISSAGGIO PER REGOLATORI. DISTANZA DAL MURO 2,5 CM.

CODE	SIZE
YB311	1/8 - 1/4
YB312	3/8 - 1/2

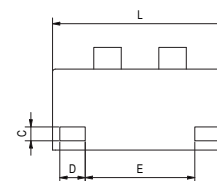
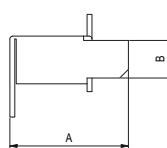
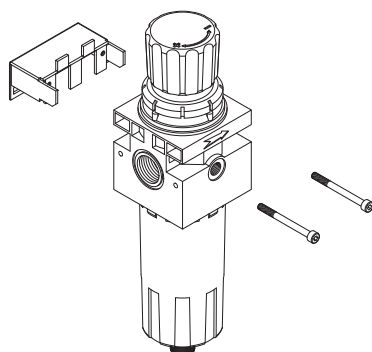
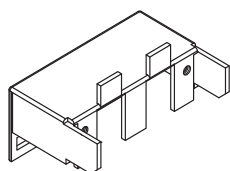

CODICE	TAGLIA	A	B	C	D	E	L
YB311	1/8 - 1/4	31	8	5	5	18,5	42
YB312	3/8 - 1/2	41	13	5	9	35,5	60,5