



Angular grippers with 180° opening are the ideal solution to limited space requirements and where is necessary necessity to have fully retractable jaws, avoiding the impact with other machine's components. This series of grippers allows the possibility to install magnetic round switches on the two main surfaces. Available sizes: Ø10, 16, 20 and 25 mm.

Les pincés angulaires avec ouverture à 180° sont idéales lorsque l'espace est limité. En effet les mâchoires sont entièrement rétractables, et évitent l'impact avec d'autres composants de la machine. Cette série de pincés permet d'installer des capteurs magnétiques ronds sur les deux faces principales. Tailles disponibles : Ø10, 16, 20 et 25 mm.

Le pinze ad apertura angolare a 180° sono la soluzione ideale ad esigenze di ingombro e alla necessità che le due griffe si ritirino completamente, impedendo l'impacco con altre parti della macchina. In questa pinza è possibile montare sensori magnetici tondi sulle due facciate principali. Taglie disponibili: Ø10, 16, 20 e 25mm.

ORDERING CODE / CODIFICATION / CHIAVE DI CODIFICA

P G 3 0 0

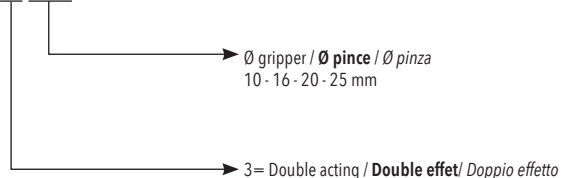

TECHNICAL DATA / DONNÉES TECHNIQUES / DATI TECNICI

Standard bore / Taille standard / Taglie standard	Ø 10 - 16 - 20 - 25 mm
Fluid / Fluide / Fluido	Lubricated or non lubricated air / Air lubrifié ou non lubrifié / Aria con o senza lubrificazione
Operating temperature range / Température d'utilisation / Temp. di esercizio	-10°C / +60°C
Pressure range / Pression d'utilisation / Pressione di utilizzo	2 - 7 bar
Action tolerance / Tolérance d'action / Tolleranza d'azione	± 0.2 mm
Max operating frequency / Fréquence de fonctionnement max. / Max frequenza operativa	60 c.p.m.

HOLDING POINT / POINT DE PRÉHENSION / PUNTO DI PRESA

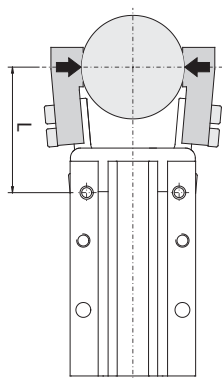

Ø10

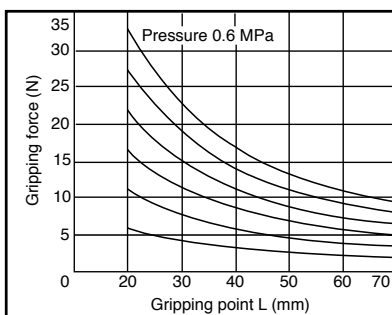

Ø16

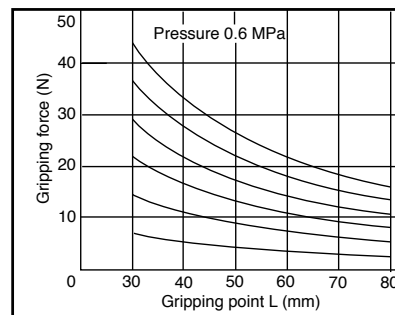

Ø20

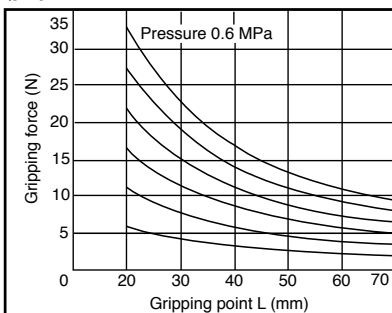

Ø25

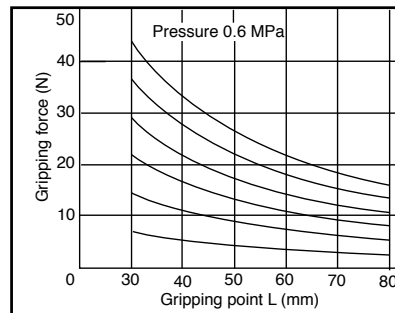

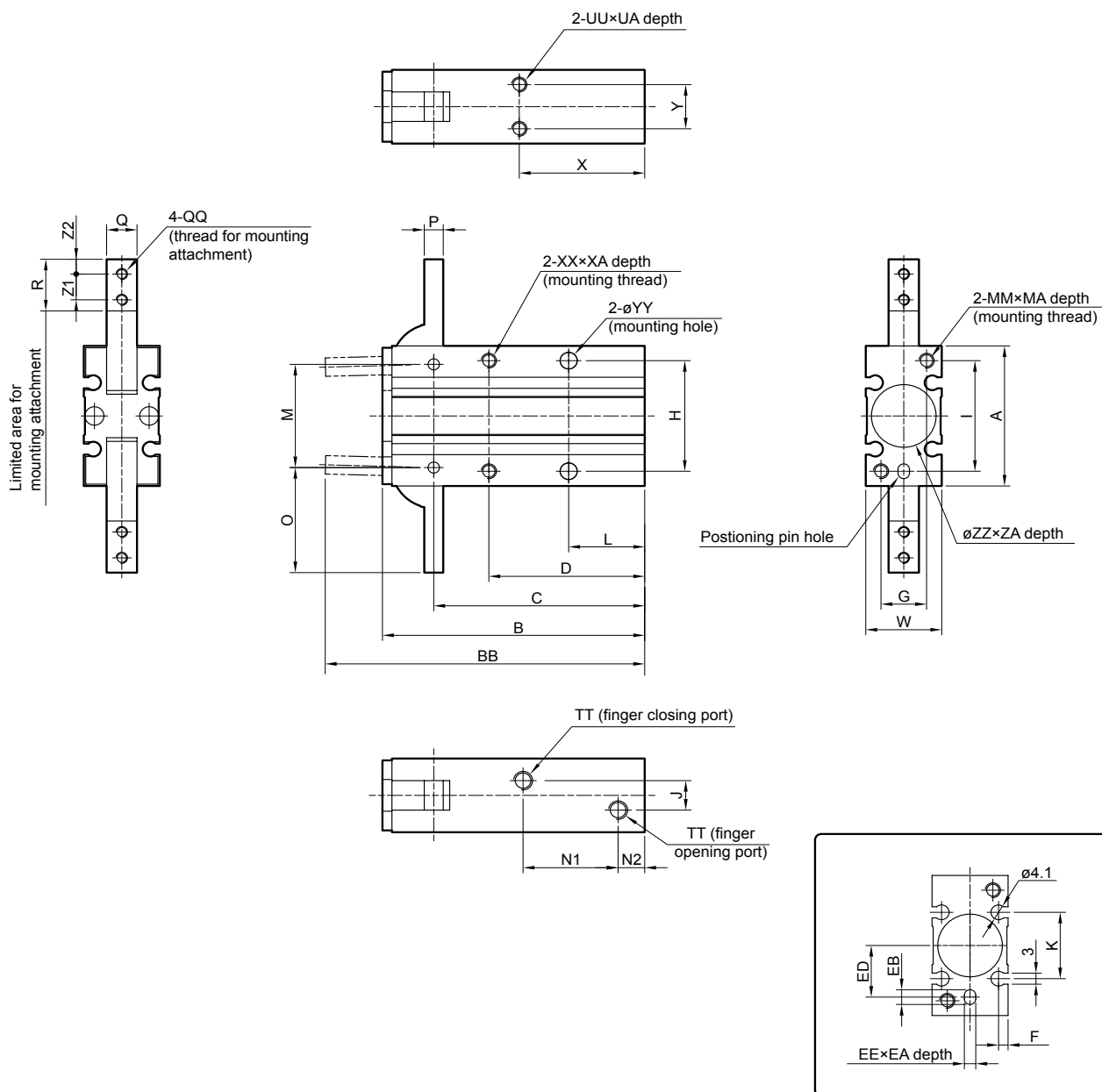

∅	A	B	BB	C	D	EE	EA	EB	ED	F	G	H	I	J	K	L	M	MA	MM	N1	N2
10	30	58	71	47.5	35	3H9	3	4	9	2	9	24	24	3	13	18	22	6	M3x0.5	23	7
16	38	69	84	55.5	41	3H9	3	4	15	2.5	12	30	30	8	18	20	28	8	M4x0.7	25	7
20	48	86	106	69	50	4H9	4	5	19	3	16	36	38	12	20	25	36	10	M5x0.8	32	8
25	58	107	131	86	60	4H9	4	5	23	3	18	42	46	14	24	30	45	12	M6x1	42	8

∅	O	P	Q	QH	QQ	R	TT	UA	UU	W	X	XA	XX	Y	YY	ZA	ZZ	Z1	Z2
10	23.5	4	6	3.4	M3x0.5	12	M5X0.8	4	M3x0.5	15	30	6	M3x0.5	9	3.4	1.5	11H9	6	3
16	28.5	5	8	3.4	M3x0.5	14	M5X0.8	5	M4x0.7	20	33	8	M4x0.7	12	4.5	1.5	17H9	7	4
20	37	8	10	4.5	M4x0.7	18	M5X0.8	8	M5x0.8	26	42	10	M5x0.8	14	5.5	1.5	21H9	9	5
25	45	10	12	5.5	M5x0.8	22.5	M5X0.8	10	M6x1	30	50	12	M6x1	16	6.6	1.5	26H9	12	6

ROUND SWITCH
CAPTEUR ROND
 SENSORE TONDO

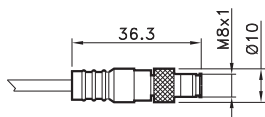
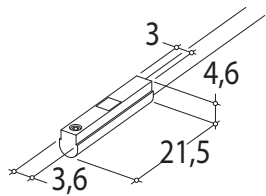

4= black / **noire** / nero
 1= brown / **brun** / marrone
 3= blue / **bleu** / azzurro

CODE

AR4018010	REED (MT.2,5) / REED (MT.2,5) / REED (MT.2,5)
AR4018020	HALL (MT.2,5) / HALL (MT.2,5) / HALL (MT.2,5)
AR4018110	REED + M8 (CM 30) / REED + M8 / REED + M8 (CM 30)
AR4018120	HALL + M8 (CM 30) / HALL + M8 / HALL + M8 (CM 30)

For technical data see page 1.75

Pour les données techniques, voir page 1.75

Per i dati tecnici vedere pag. 1.75