



Touch fittings are mainly used during "plastic" tubes assembly for pneumatic installation especially in case of vibrations or extreme climatic conditions (that involve changes on tube features by passing time).
 The fitting tube connection takes place through.

Le raccord à coiffe est particulièrement approprié dans l'assemblage de tuyaux "plastique" pour les systèmes pneumatiques, en particulier là où il peut y avoir des vibrations ou des conditions climatiques extrêmes (qui pourront dans le temps altérer les caractéristiques du tube).
Le raccordement du tuyau au raccord se fait grâce au serrage d'un écrou qui le rend sûr et fiable dans le temps.

I raccordi a calzamento sono particolarmente adatti negli assemblaggi di tubi "plastici" in impianti pneumatici, in particolar modo dove possano esserci vibrazioni o condizioni climatiche estreme (che comportano nel tempo mutamenti alle caratteristiche del tubo). L'aggancio del tubo al raccordo avviene infatti attraverso il serraggio di una ghiera che lo rende sicuro e affidabile nel tempo.

ORDERING CODE / CODIFICAZIONI / CHIAVE DI CODIFICA

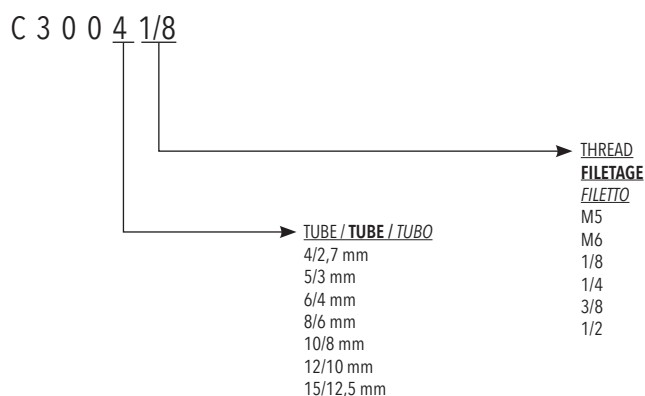

TECHNICAL DATA / DONNÉES TECHNIQUES / DATI TECNICI

Fluid / Fluide / Fluido	Air / Air / Aria
Temperature range / Température d'utilisation / Temperatura di esercizio	- 20°C / +80°C
Max operating pressure / Pression d'utilisation max. / Pressione massima	20 bar
Material / Matière / Materiale	Brass / Laiton / Ottone UNI EN 12164 CW 614N Brass / Laiton / Ottone UNI EN 12165 CW 617N
Surface used / Traitement de surface / Trattamento superficiale	Nickel-plating / Nickelage / Nichelatura
Threads / Filetage / Filettature	Parallel / cylindrique / Cilindrica DIN EN ISO 228 Taper / Conique / Conico DIN EN 10226 (DIN 2999) Metric / Métrique / Metrico DIN ISO 262
Recommended tubes / Tubes recommandés / Tubi raccomandati	Nylon, polyethylene, Rilsan, polyurethane Nylon, polyéthylène, PVC Rilsan, polyuréthane Nylon, polietilene, PVC Rilsan, poliuretano

C301

STRAIGHT MALE ADAPTOR TAPER / **DROIT MÂLE CONIQUE** / *DIRITTO MASCHIO CONICO*

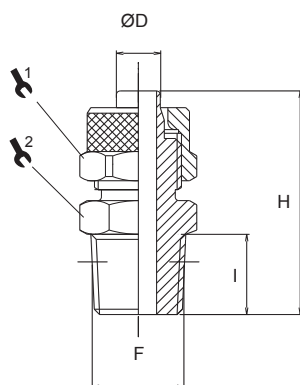

CODE	ØD	F	I	H	1	2	min.pcs.
C301 4-1/8	4/2,7	R1/8	8,0	23,8	8	12	10
C301 5-1/8	5/3	R1/8	8,0	25,0	8	12	10
C301 6-1/8	6/4	R1/8	8,0	27,5	12	12	10
C301 6-1/4	6/4	R1/4	11,0	31,0	12	14	10
C301 6-3/8	6/4	R3/8	11,5	31,5	12	17	10
C301 8-1/8	8/6	R1/8	8,0	27,5	14	12	10
C301 8-1/4	8/6	R1/4	11,0	31,0	14	14	10
C301 8-3/8	8/6	R3/8	11,5	31,5	14	17	10
C301 8-1/2	8/6	R1/2	14,0	34,5	14	22	10
C301 10-1/8	10/8	R1/8	8,0	29,5	16	14	10
C301 10-1/4	10/8	R1/4	11,0	32,5	16	14	10
C301 10-3/8	10/8	R3/8	11,5	33,0	16	17	10
C301 10-1/2	10/8	R1/2	14,0	36,0	16	22	10
C301 12-3/8	12/10	R3/8	11,5	34,5	18	17	10
C301 12-1/2	12/10	R1/2	14,0	37,5	18	22	10
C301 15-1/2	15/12,5	R1/2	14,0	39,5	22	22	10

C302

STRAIGHT MALE ADAPTOR PARALLEL / **DROIT MÂLE CYLINDRIQUE** / *DIRITTO MASCHIO CILINDRICO*

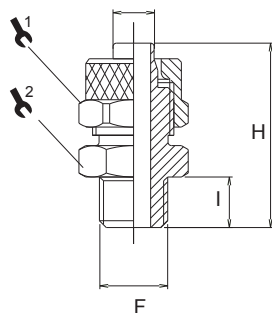

CODE	ØD	F	I	H	1	2	min.pcs.
C302 5-1/8	5/3	G1/8	6,0	23,0	8	14	10
C302 6-1/8	6/4	G1/8	6,0	25,5	12	14	10
C302 6-1/4	6/4	G1/4	8,0	28,0	12	17	10
C302 6-3/8	6/4	G3/8	9,0	29,0	12	19	10
C302 8-1/8	8/6	G1/8	6,0	25,5	14	14	10
C302 8-1/4	8/6	G1/4	8,0	28,0	14	17	10
C302 8-3/8	8/6	G3/8	9,0	29,0	14	19	10
C302 10-1/8	10/8	G1/8	6,0	27,0	16	14	10
C302 10-1/4	10/8	G1/4	8,0	29,5	16	17	10
C302 10-3/8	10/8	G3/8	9,0	30,5	16	19	10
C302 10-1/2	10/8	G1/2	10,0	32,0	16	24	10
C302 12-3/8	12/10	G3/8	9,0	32,0	18	19	10
C302 12-1/2	12/10	G1/2	10,0	33,5	18	24	10
C302 15-1/2	15/12,5	G1/2	10,0	35,5	22	24	10

C302C

STRAIGHT MALE ADAPTOR PARALLEL WITH O-RING / **DROIT MÂLE CYLINDRIQUE AVEC JOINT** / *DIRITTO MASCHIO CILINDRICO CON O-RING*

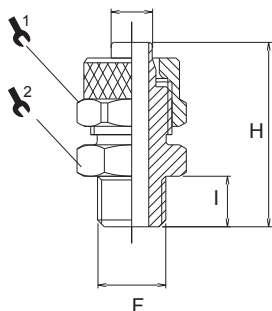

CODE	ØD	F	I	H	1	2	min.pcs.
C302C 4-1/8	4/3	G1/8	-	-	-	-	10
C302C 5-1/8	5/3	G1/8	6,0	23,0	8	14	10
C302C 6-1/8	6/4	G1/8	6,0	25,5	12	14	10
C302C 6-1/4	6/4	G1/4	8,0	28,0	12	17	10
C302C 6-3/8	6/4	G3/8	9,0	29,0	12	19	10
C302C 6-1/2	6/4	G1/2	-	-	-	-	10
C302C 8-1/8	8/6	G1/8	6,0	25,5	14	14	10
C302C 8-1/4	8/6	G1/4	8,0	28,0	14	17	10
C302C 8-3/8	8/6	G3/8	9,0	29,0	14	19	10
C302C 8-1/2	8/6	G1/2	-	-	-	-	10
C302C 10-1/8	10/8	G1/8	6,0	27,0	16	14	10
C302C 10-1/4	10/8	G1/4	8,0	29,5	16	17	10
C302C 10-3/8	10/8	G3/8	9,0	30,5	16	19	10
C302C 10-1/2	10/8	G1/2	10,0	32,0	16	24	10
C302C 12-3/8	12/10	G3/8	9,0	32,0	18	19	10
C302C 12-1/2	12/10	G1/2	10,0	33,5	18	24	10
C302C 15-1/2	15/12,5	G1/2	10,0	35,5	22	24	10

C304



STRAIGHT FEMALE ADAPTOR / **DROIT FEMELLE** / **DIRITTO FEMMINA**

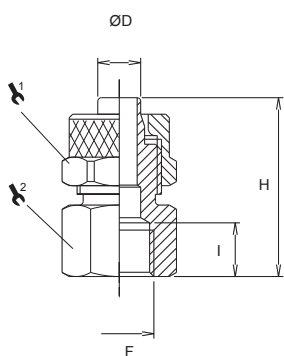

CODE	ØD	F	I	H	1	2	min.pcs.
C304 4-1/8	4/2,7	G1/8	8,0	21,3	8	14	10
C304 5-1/8	5/3	G1/8	8,0	22,5	8	14	10
C304 6-1/8	6/4	G1/8	8,0	25,0	12	14	10
C304 6-1/4	6/4	G1/4	11,0	29,0	12	17	10
C304 6-3/8	6/4	G3/8	11,5	29,5	12	20	10
C304 8-1/8	8/6	G1/8	8,0	25,0	14	14	10
C304 8-1/4	8/6	G1/4	11,0	29,0	14	17	10
C304 8-3/8	8/6	G3/8	11,5	29,5	14	20	10
C304 10-1/8	10/8	G1/8	8,0	26,5	16	14	10
C304 10-1/4	10/8	G1/4	11,0	30,5	16	17	10
C304 10-3/8	10/8	G3/8	11,5	31,0	16	20	10
C304 10-1/2	10/8	G1/2	14,0	34,5	16	24	10
C304 12-3/8	12/10	G3/8	11,5	32,5	18	20	10

C305



UNION CONNECTOR / **DROIT DOUBLE** / **DIRITTO INTERMEDIO**

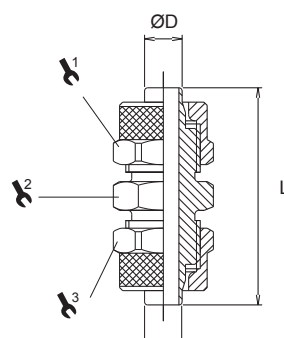

CODE	ØD	L	1	2	3	min.pcs.
C305 4	4/2,7	26,1	8	8	8	10
C305 5	5/3	28,5	8	8	8	10
C305 6	6/4	34,5	12	12	12	10
C305 8	8/6	35,0	14	14	12	10
C305 8-6	8/6x6/4	35,0	14	14	14	10
C305 10	10/8	38,0	16	16	14	10
C305 12	12/10	41,0	18	17	18	10
C305 15	15/12,5	45,5	22	22	22	10

C306



BULKHEAD CONNECTOR / **TRAVERSÉE DE CLOISON** / **DIRITTO PASSAPARETE**

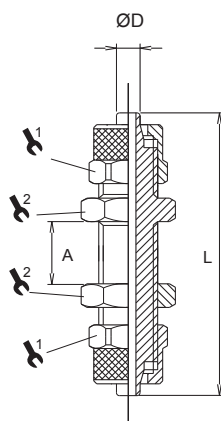

CODE	ØD	Amax	L	1	2	min.pcs.
C306 4	4/2,7	8,5	36,7	8	8	10
C306 5	5/3	8,5	40,0	8	9	10
C306 6	6/4	10,5	48,0	12	14	10
C306 8	8/6	10,5	48,0	14	16	10
C306 10	10/8	8,5	50,0	16	17	10
C306 12	12/10	8,5	53,0	18	19	10
C306 15	15/12,5	8,5	58,0	22	24	10

C307

MALE ELBOW TAPER / ÉQUERRE MALE CONIQUE / L MASCHIO CONICO

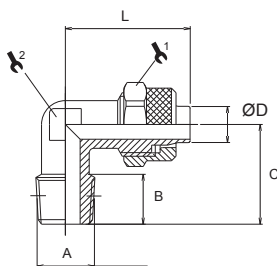

CODE	ØD	A	B	C	L	1/2	1/2	min.pcs.
C307 4-1/8	4/2,7	R1/8	8,0	17,0	19,5	8	8	10
C307 5-1/8	5/3	R1/8	8,0	17,0	21,5	8	8	10
C307 6-1/8	6/4	R1/8	8,0	17,0	22,5	12	8	10
C307 6-1/4	6/4	R1/4	11,0	20,0	22,5	12	10	10
C307 6-3/8	6/4	R3/8	11,5	22,5	23,5	12	11	10
C307 8-1/8	8/6	R1/8	8,0	17,0	22,5	14	10	10
C307 8-1/4	8/6	R1/4	11,0	20,0	22,5	14	10	10
C307 8-3/8	8/6	R3/8	11,5	22,5	24,0	14	11	10
C307 10-1/8	10/8	R1/8	8,0	18,5	25,5	16	11	10
C307 10-1/4	10/8	R1/4	11,0	21,5	25,5	16	11	10
C307 10-3/8	10/8	R3/8	11,5	22,5	25,5	16	11	10
C307 10-1/2	10/8	R1/2	14,0	28,0	28,0	16	17	10
C307 12-1/4	12/10	R1/4	11,0	24,0	30,0	18	14	10
C307 12-3/8	12/10	R3/8	11,5	24,5	30,0	18	14	10
C307 12-1/2	12/10	R1/2	14,0	28,0	30,5	18	17	10
C307 15-1/2	15/12,5	R1/2	14,0	28,0	34,0	22	17	10

C308C

ROTARY MALE ELBOW PARALLEL / ÉQUERRE MALE CYLINDRIQUE / L GIREVOLE MASCHIO CILINDRICO

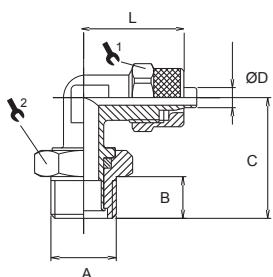

CODE	ØD	A	B	C	L	1/2	1/2	min.pcs.
C308C 4-1/8	4/2,7	G1/8	6,0	22,5	21,5	12	14	10
C308C 6-1/8	6/4	G1/8	6,0	22,5	22,5	12	14	10
C308C 6-1/4	6/4	G1/4	8,0	25,0	23,5	12	17	10
C308C 8-1/8	8/6	G1/8	6,0	22,5	23,5	14	14	10
C308C 8-1/4	8/6	G1/4	8,0	25,0	23,5	14	17	10
C308C 10-1/4	10/8	G1/4	8,0	25,5	25,5	16	17	10

C310

FEMALE ELBOW / ÉQUERRE FEMELLE / L FEMMINA

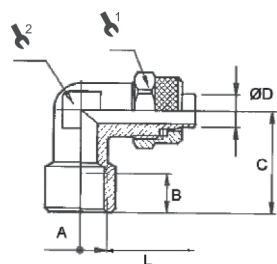

CODE	ØD	A	B	C	L	1/2	1/2	min.pcs.
C310 5-1/8	5/3	G1/8	8,0	19,0	21,5	8	10	10
C310 6-1/8	6/4	G1/8	8,0	19,0	22,5	12	10	10
C310 6-1/4	6/4	G1/4	10,5	23,0	25,0	12	11	10
C310 8-1/8	8/6	G1/8	8,0	19,0	22,5	14	10	10
C310 8-1/4	8/6	G1/4	10,5	23,0	25,0	14	11	10
C310 10-1/4	10/8	G1/4	11,0	23,5	26,0	16	13	10
C310 12-3/8	12/10	G3/8	11,5	28,0	30,5	18	17	10

C311

UNION ELBOW / ÉQUERRE DOUBLE / L INTERMEDIO

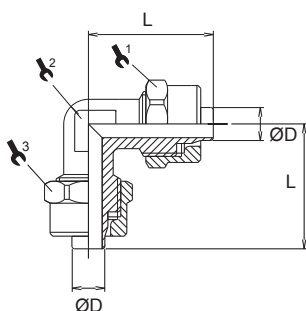

CODE	ØD	L	1/2	1/2	1/2	min.pcs.
C311 4	4/2,7	20,3	8	8	8	10
C311 5	5/3	21,5	8	8	8	10
C311 6	6/4	21,5	12	8	12	10
C311 8	8/6	22,5	12	10	14	10
C311 8-6	8/6x6/4	22,5	14	10	14	10
C311 10	10/8	25,5	16	11	16	10
C311 12	12/10	30,0	18	14	18	10
C311 15	15/12,5	34,0	22	17	22	10

C313



MALE TEE TAPER / T CONIQUE / T CENTRALE CONICO

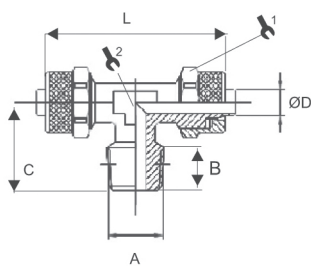

CODE	ØD	A	B	C	L	1	2	min.pcs.
C313 4-1/8	4/2,7	R1/8	8,0	17,0	40,6	8	8	10
C313 5-M5	5/3	M5	4,0	15,0	43,0	8	8	10
C313 5-1/8	5/3	R1/8	8,0	17,0	43,0	8	8	10
C313 6-1/8	6/4	R1/8	8,0	17,0	45,0	11	8	10
C313 6-1/4	6/4	R1/4	11,0	20,5	45,5	11	10	10
C313 6-3/8	6/4	R3/8	11,5	22,5	47,0	12	11	10
C313 8-1/8	8/6	R1/8	8,0	17,5	45,5	14	10	10
C313 8-1/4	8/6	R1/4	11,0	20,5	45,5	14	10	10
C313 8-3/8	8/6	R3/8	11,5	21,5	48,0	14	11	10
C313 10-1/8	10/8	R1/8	8,0	18,5	51,0	16	11	10
C313 10-1/4	10/8	R1/4	11,0	21,5	51,0	16	11	10
C313 10-3/8	10/8	R3/8	11,5	22,5	51,0	16	11	10
C313 10-1/2	10/8	R1/2	14,0	28,0	57,0	16	17	10
C313 12-3/8	12/10	R3/8	11,5	22,5	60,0	18	14	10
C313 12-1/2	12/10	R1/2	14,0	28,0	61,0	18	17	10
C313 15-1/2	15/12,5	R1/2	14,0	28,0	68,0	22	17	10

C313C



MALE TEE PARALLEL / T CYLINDRIQUE / T CENTRALE CILINDRICO

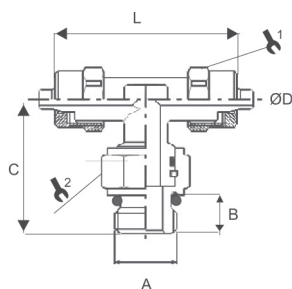

CODE	ØD	A	B	C	L	1	2	min.pcs.
C313C 4-1/8	4/2,7	G1/8	6,0	25,7	45,0	8	13	10
C313C 6-1/8	6/4	G1/8	6,0	25,7	45,0	12	13	10
C313C 6-1/4	6/4	G1/4	8,0	29,0	45,5	12	16	10
C313C 8-1/8	8/6	G1/8	6,0	26,0	45,5	10	14	10
C313C 8-1/4	8/6	G1/4	8,0	28,0	45,5	14	16	10
C313C 10-1/4	10/8	G1/4	8,0	29,0	51,0	16	16	10

C314



LATERAL MALE TEE TAPER / T LATERAL CONIQUE / T LATERALE CONICO

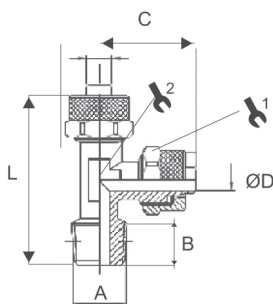

CODE	ØD	A	B	C	L	1	2	min.pcs.
C314 4-1/8	4/2,7	R1/8	8,0	21,5	38,0	8	8	10
C314 5-M5	5/3	M5	4,0	21,5	36,5	8	8	10
C314 5-1/8	5/3	R1/8	8,0	21,5	38,5	8	8	10
C314 6-1/8	6/4	R1/8	8,0	22,5	39,5	12	8	10
C314 6-1/4	6/4	R1/4	11,0	22,5	42,5	12	10	10
C314 6-3/8	6/4	R3/8	11,5	24,0	46,5	12	11	10
C314 8-1/8	8/6	R1/8	8,0	22,5	40,5	14	10	10
C314 8-1/4	8/6	R1/4	11,0	22,5	43,5	14	10	10
C314 8-3/8	8/6	R3/8	11,5	23,5	46,5	14	11	10
C314 10-1/8	10/8	R1/8	8,0	25,5	44,0	16	11	10
C314 10-1/4	10/8	R1/4	11,0	25,5	46,5	16	11	10
C314 10-3/8	10/8	R3/8	11,5	25,5	48,0	16	11	10
C314 10-1/2	10/8	R1/2	14,0	29,0	57,0	16	17	10
C314 12-3/8	12/10	R3/8	11,5	30,0	54,5	18	14	10
C314 12-1/2	12/10	R1/2	14,0	30,5	58,5	18	17	10
C314 15-1/2	15/12,5	R1/2	14,0	34,0	62,0	22	17	10

C315



UNION TEE / T / INTERMEDIO

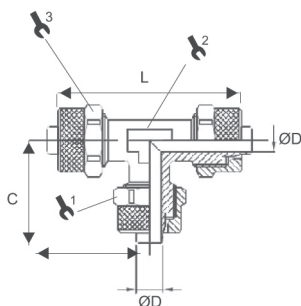

CODE	ØD	C	L	1	2	3	min.pcs.
C315 4	4/2,7	20,3	20,3	8	8	8	10
C315 5	5/3	21,5	43,0	8	8	8	10
C315 6	6/4	22,5	45,0	12	8	12	10
C315 8-6	8/6x6/4	22,5	45,0	14	10	14	10
C315 8	8/6	22,5	45,0	12	10	14	10
C315 10	10/8	25,5	51,0	16	11	16	10
C315 12	12/10	30,0	60,0	18	14	18	10
C315 15	15/12,5	34,0	68,0	22	17	22	10

C322



NUT / ECROU / DADO

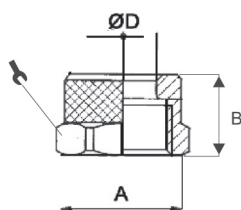

CODE	ØD	A	B	1	min.pcs.
C322 4	4/2,7	M6x0,5	8,1	8	10
C322 5	5/3	M7x0,75	8,5	8	10
C322 6-8	6/4	M8x0,75	9,0	9	10
C322 6	6/4	M10x1	10,5	12	10
C322 8	8/6	M12x1	10,5	14	10
C322 10	10/8	M14x1	11,5	16	10
C322 12	12/10	M16x1	13,0	18	10
C322 15	15/12,5	M20x1	15,5	22	10

C312



CROSS UNION / CROIX / CROCE INTERMEDIO

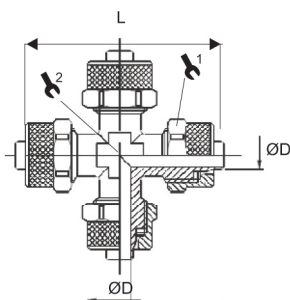

CODE	ØD	L	1	2	min.pcs.
C312 5	5/3	43,0	8	8	10
C312 6	6/4	45,0	12	8	10
C312 8	8/6	45,0	14	10	10
C312 10	10/8	51,0	16	11	10

E533

MALE CONNECTOR SWIVEL WITH SPRING PARALLEL / **DROIT MÂLE CONIQUE AVEC RESSORT**
 DIRITTO MASCHIO GIREVOLE CONICO CON MOLLA

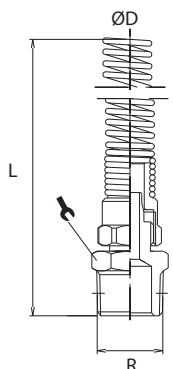

CODE	TUBO	R	L	1	2	min.pcs.
E533 6/4 1/4	6/4	1/4	113,0	14	14	10
E533 8/5 1/4	8/5	1/4	124,5	12	12	10
E533 8/6 1/4	8/6	1/4	128,0	14	14	10
E533 8/6 3/8	8/6	3/8	128,5	17	17	10
E533 10/8 1/4	10/8	1/4	125,0	14	14	10
E533 10/8 3/8	10/8	3/8	125,5	17	17	10
E533 12/10 3/8	12/10	3/8	140,0	22	22	10

E534

MALE CONNECTOR SWIVEL WITH SPRING TAPER / **DROIT MÂLE CONIQUE ROTATIF AVEC RESSORT**
 DIRITTO MASCHIO GIREVOLE CONICO CON MOLLA

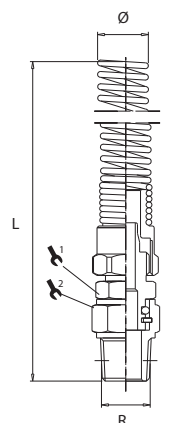

CODE	TUBO	R	L	1	2	min.pcs.
E534 6/4 1/4	6/4	1/4	118,9	15	13	10
E534 8/5 1/4 *	8/5	1/4	124,4	13	13	10
E534 8/6 1/4	8/6	1/4	124,4	16	16	10
E534 10/6,5 1/4 *	10/6,5	1/4	132,4	16	16	10
E534 10/8 1/4	10/8	1/4	132,4	13	13	10
E534 12/8 3/8	12/8	3/8	141,9	16	16	10
E534 12/10 3/8	12/10	3/8	141,9	16	16	10

* Special measures for PU tube
 Mesures spécifiques pour tube de polyuréthane
 Misure specifiche per tubo in poliuretano

E535

ROTARY MALE CONNECTOR SWIVEL WITH SPRING PARALLEL / **DROIT MÂLE CYLINDRIQUE AVEC RESSORT**
 DIRITTO MASCHIO GIREVOLE CON MOLLA

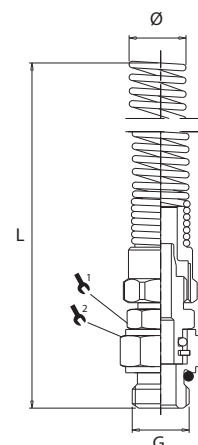

CODE	TUBO	R	L	1	2	min.pcs.
E535 6/4 1/8	6/4	1/8	116,9	13	13	10
E535 6/4 1/4	6/4	1/4	118,9	13	13	10
E535 8/5 1/8 *	8/5	1/8	122,4	16	16	10
E535 8/5 1/4 *	8/5	1/4	124,4	13	13	10
E535 8/6 1/8	8/6	1/8	122,4	16	16	10
E535 8/6 1/4	8/6	1/4	124,4	16	16	10
E535 10/6,5 1/4 *	10/6,5	1/4	132,4	16	16	10
E535 10/8 1/4	10/8	1/4	132,4	13	13	10
E535 12/8 3/8	12/8	3/8	141,9	16	16	10
E535 12/10 3/8	12/10	3/8	141,9	16	16	10

* Special measures for PU tube
 Mesures spécifiques pour tube de polyuréthane
 Misure specifiche per tubo in poliuretano

E536

FIXED MALE CONNECTOR WITH SPRING PARALLEL / **DROIT MÂLE CYLINDRIQUE AVEC RESSORT**
DIRITTO MASCHIO FISSO CILINDRICO CON MOLLA

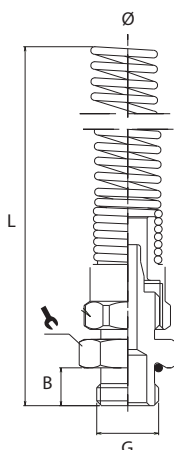

CODE	TUBO	G	B	L		min.pcs.
E536 6/4 1/8	6/4	1/8	6,0	111,0	13	10
E536 6/4 1/4	6/4	1/4	8,0	111,0	16	10
E536 6/4 3/8	6/4	3/8	9,0	112,0	19	10
E536 6/4 1/2	6/4	1/2	10,0	113,0	24	10
E536 8/6 1/8	8/6	1/8	6,0	110,0	14	10
E536 8/6 1/4	8/6	1/4	8,0	111,0	16	10
E536 8/6 3/8	8/6	3/8	9,0	112,0	19	10
E536 8/6 1/2	8/6	1/2	10,0	113,0	24	10
E536 10/8 1/8	10/8	1/8	6,0	116,0	14	10
E536 10/8 1/4	10/8	1/4	8,0	117,0	16	10
E536 10/8 3/8	10/8	3/8	9,0	118,5	19	10
E536 10/8 1/2	10/8	1/2	10,0	119,0	24	10
E536 12/10 3/8	12/10	3/8	9,0	129,0	19	10
E536 12/10 1/2	12/10	1/2	10,0	130,0	24	10

C316

SINGLE BANJO BODY / **BANJO ORIENTABLE** / ANELLO ORIENTABILE SINGOLO

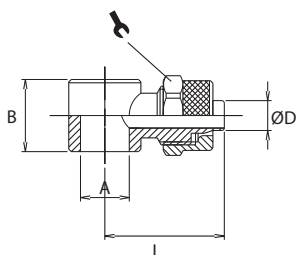

CODE	ØD	A	B	L		min.pcs.
C316 4/2,7-M5	4/2,7	M5	9,0	15,8	8	10
C316 4/2,7-M6	4/2,7	M6	9,0	15,8	8	10
C316 4/2,7-1/8	4/2,7	G1/8	14,5	21,3	8	10
C316 5/3-M5	5/3	M5	9,0	17,0	8	10
C316 5/3-1/8	5/3	G1/8	14,5	22,5	8	10
C316 6/4-M5	6/4	M5	9,0	18,0	9	10
C316 6/4-1/8	6/4	G1/8	14,5	24,0	12	10
C316 6/4-1/4	6/4	G1/4	14,5	26,0	12	10
C316 8/6-1/8	8/6	G1/8	14,5	24,0	14	10
C316 8/6-1/4	8/6	G1/4	14,5	26,0	14	10
C316 10/8-1/4	10/8	G1/4	14,5	27,5	16	10

C317

DOUBLE BANJO BODY / **BANJO ORIENTABLE DOUBBLE** / ANELLO ORIENTABILE DOPPIO

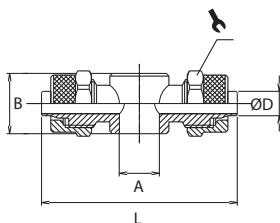

CODE	ØD	A	B	L		min.pcs.
C317 4/2,7-1/8	4/2,7	G1/8	14,5	42,6	8	10
C317 5/3-1/8	5/3	G1/8	14,5	45,0	8	10
C317 6/4-1/8	6/4	G1/8	14,5	48,0	12	10
C317 6/4-1/4	6/4	G1/4	14,5	52,0	12	10
C317 8/6-1/8	8/6	G1/8	14,5	48,0	14	10
C317 8/6-1/4	8/6	G1/4	14,5	52,0	14	10
C317 10/8-1/4	10/8	G1/4	14,5	55,0	16	10

C319

SINGLE STEM / **VIS SIMPLE** / *ASTA SINGOLA*

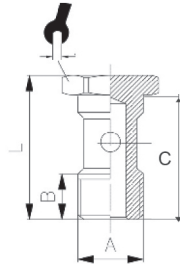

CODE	A	B	C	L		min.pcs.
C319 M5	M5	6,0	14,5	18,0	8	10
C319 M6	M6	6,0	14,5	18,5	8	10
C319 1/8	G1/8	8,0	23,0	27,0	14	10
C319 1/4	G1/4	11,0	25,0	29,5	17	10

C321

DOUBLE STEM / **VIS DOUBLE** / *ASTA DOPPIA*

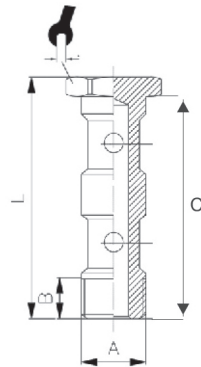

CODE	A	B	C	L		min.pcs.
C321 1/8	G1/8	8,0	39,0	43,0	14	10
C321 1/4	G1/4	11,0	41,0	45,5	17	10

C327

NYLON WASHER / **RONDELLE EN NYLON** / *DISTANZIALE NYLON*

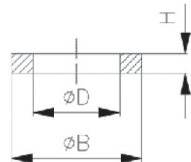

CODE	ØD	ØB	H	min.pcs.
C327 1/8	10,0	14,0	5,0	10
C327 1/4	13,2	17,5	5,0	10

C318

FEMALE SINGLE BANJO / **BANJO ORIENTABLE FEMELLE** / *ANELLO GIREVOLE FEMMINA*

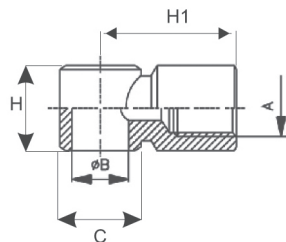

CODE	A	B	C	H	H1	min.pcs.
C318 1/8	G1/8	G1/8	14,0	14,5	20,0	10
C318 1/4	G1/4	G1/4	18,0	17,5	24,5	10
C318 3/8	G3/8	G3/8	21,0	21,0	29,0	10

C325

NYLON NOTCHED WASHER / **RONDELLE EN NYLON** / *RONDELLA NYLON DENTELLATA*

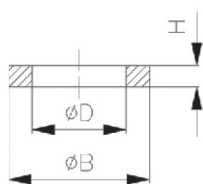

CODE	D	B	H	min.pcs.
C325 M5	5,2	8,0	1,3	10
C325 1/8	10,0	14,0	2,0	10
C325 1/4	13,5	18,0	2,0	10
C325 3/8	16,8	21,0	2,0	10
C325 1/2	21,1	26,0	2,0	10

C324

NYLON WASHER / **RONDELLE EN NYLON** / *RONDELLA NYLON*

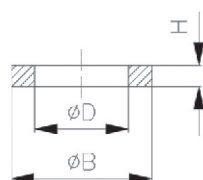

CODE	D	B	H	min.pcs.
C324 M5	5,3	7,7	1,0	10
C324 1/8	10,2	13,0	1,5	10
C324 1/4	13,4	17,9	2,0	10
C324 3/8	17,1	21,8	2,0	10
C324 1/2	21,3	26,5	2,0	10
C324 3/4	26,7	32,4	2,0	10

C323

ALUMINIUM WASHER / **RONDELLE EN ALUMINIUM** / *RONDELLA ALLUMINIO*

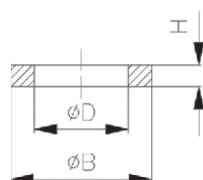
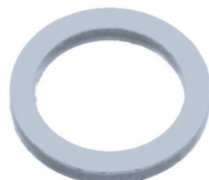

CODE	D	B	H	min.pcs.
C323 1/8	10,0	14,0	1,5	10
C323 1/4	10,3	17,3	1,5	10
C323 3/8	16,9	21,0	1,5	10
C323 1/2	21,1	26,0	1,5	10